

Gas Stoves & Inserts





Shown with deluxe 6" flashing kit in painted black and MIRRO-FLAME® Porcelain Reflective Radiant Panels.

CDI-30 - Direct Vent A Great Looking Investment

The value that a CDI-30 gas insert adds to your home is priceless! Outstanding efficiencies, up to 24,500 BTU's and a powerful heat circulating blower all contribute to the added benefit of eliminating drafts and heat loss in your existing fireplace. The CDI-30 installs perfectly into an inefficient wood burning masonry or pre-fabricated fireplace. Once installed, all you do is sit back and enjoy all the conveniences of direct vent gas technology!



Faceplates available in brushed nickel, brushed copper and painted black.



Optional River Rock media kit in grey or multi-colored is available to switch out the existing logs for a more contemporary design.



Shown with arched cast iron surround in painted black.

CBI360 - Natural Vent

Comfort and Style

The CBI360 is specifically designed to fit smaller wood burning zero clearance fireplaces and comes complete with a heat activated variable speed blower system. The CBI360 comes standard as a flush mount model, but also has decorative options including faceplates, flashings, trims, non-arched cast iron surround and an arched cast iron surround kit.



Faceplates available in brushed nickel, brushed copper and painted black.

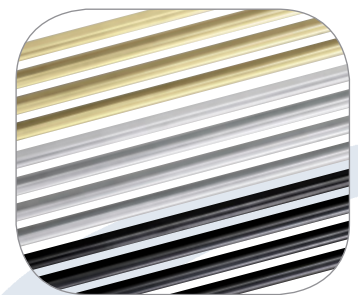

Lower louvers available in polished brass, brushed stainless steel, antique brass and painted black finishes.



Shown with painted textured satin black four-sided aluminum extrusion trim kit.



Three or four-sided aluminum extrusion trim kit available in painted textured satin black finish.



Faceplates available in brushed nickel, brushed copper and painted black.

CDIZC - Direct Vent Compact and Efficient

Accommodates the smallest fireplace openings but still provides an impressive 400 sq. in. viewing area! Designer options include three sided aluminum extrusion and contemporary trim kit, four sided aluminum extrusion, decorative faceplates, three and four sided backerplates and a cast iron surround kit.



Shown with door, accent bar and trivet in painted metallic black finish.

CDVS280 - Direct Vent* Compact in Stature, Not Power!

This stove may be compact in stature, but not in power! If you have limited space but still desire the beauty, warmth and conveniences of a gas stove, the CDVS280 is the answer. Offering a variable heat range up to 30,000 BTU's, you control the exact amount of heat needed. The precisely engineered burner system produces unique YELLOW DANCING FLAMES* which fill your room with a warm, inviting glow. This extraordinary small stove delivers great peace of mind.

*B-vent adaptor available.



Decorative accent bar and door available in painted metallic black, 24 Karat gold plated or satin chrome plated finishes.



Painted black decorative inset adds a designer's touch and comes standard.



Shown with door and accent bar in painted metallic black finish.



Decorative accent bar and door available in painted metallic black, 24 Karat gold plated or satin chrome plated finishes.

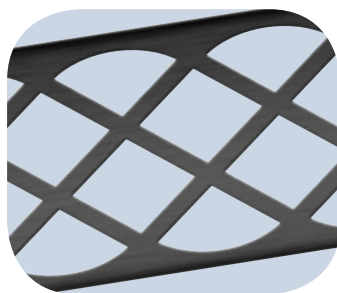

Painted metallic black decorative trivet comes standard.

CDVS500 - Direct Vent* Turbo Boost & 84% Efficiency!

The CDVS500 offers a three burner system - the third tube burner "turbo boosts" the heating power like no other stove in the industry. It operates independently to supply an additional 14,000 BTU's on top of the already impressive 30,000 BTU's. Create the right amount of heat you need. Safe, clean burning and high efficiencies make this stove a valuable addition to your home.

*B-vent adaptor available.



Shown in standard painted metallic black finish.

CDVS600 - Direct Vent*

Extreme Comfort and Style

Here is the perfect blend of traditional design and advanced gas performance. The CDVS600 allows you to express your style and capture a look of elegance while at the same time, provides a comfortable range from 21,000 BTU's to a hearth warming 35,000 BTU's. Direct vent converts easily from top to rear vent making installation possibilities endless.



Elegant fine cast iron detailing.



Decorative firebox brick panels available in Sandstone.

*B-vent adaptor available.

Gas Insert Technology

Direct Vent System

- 1 Realistic PHAZER® log set or CRYSTALINE™ ember bed
- 2 Double steel wall construction on five sides for optimum heat retention and efficiency
- 3 Variable speed fan provides maximum comfort and efficiency to help circulate room air
- 4 Cool room air is drawn in
- 5 High heat resistant ceramic glass for ultimate safety and heat transfer
- 6 Heated air is pushed into the room through an efficient variable speed blower system
- 7 Heat exchanger for maximum heat output featuring heavy gauge steel
- 8 Gas flue outlet exhausts combusted air
- 9 Fresh air intake
- 10 Exhausted combustion air

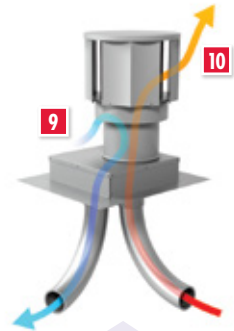

Direct vent technology draws outside air for combustion into the firebox chamber then exhausts through a separate vent. Both vents are installed into your existing chimney.

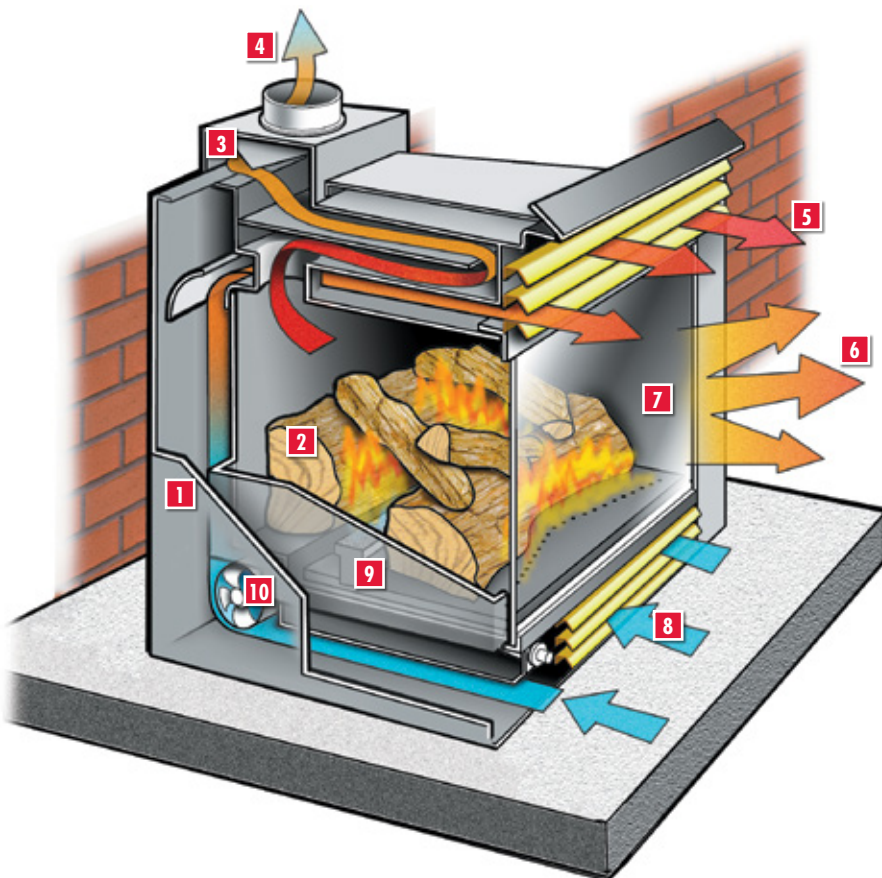
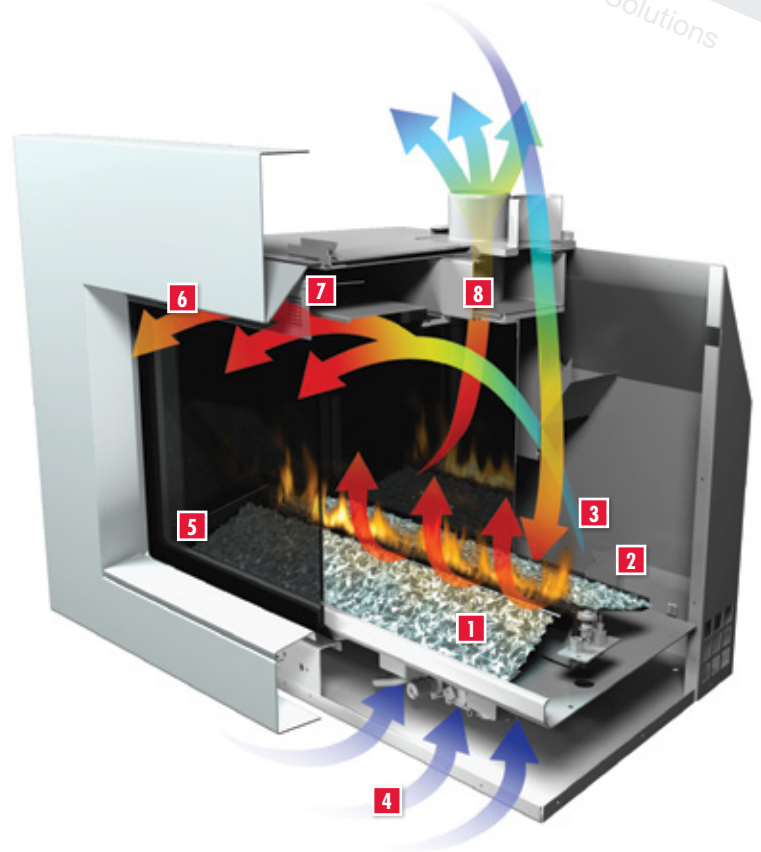

Gas Insert Technology

Natural Vent System

- 1 Double steel wall construction on five sides for optimum heat retention and efficiency
- 2 Glowing PHAZER® logs for a realistic wood burning look
- 3 Dilution hood helps eliminate down drafts
- 4 Gas flue outlet exhausts combusted air
- 5 Efficient blower system supplies heated air into the room
- 6 Radiant heat radiates into the room, even when the blower is not on
- 7 High heat ceramic glass for ultimate safety and heat transfer
- 8 Cool room air is drawn in
- 9 Dual level stainless steel burner for years of trouble free use
- 10 Variable speed fan provides maximum comfort & efficiency to help circulate room air

Accessories

It's easy to update the look of your fireplace by simply changing the decorative accessories.

Insert Louvres



Polished Brass Finish
Antique Brass Finish
Brushed Stainless Steel Finish
Painted Black Finish

Bevelled Flashing Kits

Available in 6".



Painted Textured Satin Black Finish

Deluxe Flashing Kits



6" Painted Black Finish

9" Painted Black Finish

Faceplates



Brushed Nickel

Brushed Copper

Painted Black

Cast Iron Surrounds



Painted Black Finish

Porcelain Enamel Majolica Brown Finish

Arched Cast Iron Surround & Door Kit



Available for CDI-30 & CBI360.

Firebox Panel Options

Firebox panels add a masonry or a contemporary feel to your firebox.

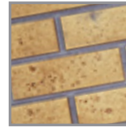

Decorative Sandstone Brick



MIRRO-FLAME[™] Porcelain Reflective Radiant Panels

River Rock Media Kits

Switch out existing logs to a more contemporary river rock setting. Available for CDI-30.



Grey



Multi-colored

Andirons

Designed to simply stand in front of the logs and give the optimum masonry look and feel. Available in Painted Black.



Riser Box

Available in Painted Black Finish.



Remote Controls

Remotes with digital read out and modulating control give you the comfort level you need at the touch of a button.



Door & Accent Bar Options

Available for CDVS280 & CDVS500.

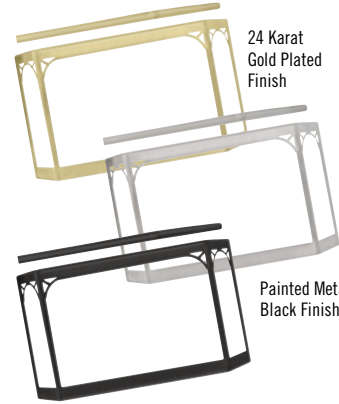

24 Karat Gold Plated Finish

Satin Chrome Plated Finish

Painted Metallic Black Finish

Extrusion Trim Kits

Available in Painted Textured Satin Black finish.



Three-Sided Kit

Four-Sided Kit

Contemporary Trim Kit



	CDI-30	CBI360	CDIC	CDVS280	CDVS500	CDVS600
Electronic Ignition	-	-	-	-	-	S
Stove Doors (Painted Metallic Black, Satin Chrome Plated or 24 Karat Gold Plated finishes)	-	-	-	0	0	-
Louvres (Polished Brass, Antique Brass, Brushed Stainless Steel or Painted Black finishes)	0	0	-	-	-	-
Ornamental Inset and Trivet (Painted Black finish)	-	-	-	S	S	-
Faceplates (Brushed Nickel, Brushed Copper or Painted Black finishes)	0 •	0 •	0 •	-	-	-
Bevelled Flashing Kit	0	0	-	-	-	-
6" and 9" Deluxe Flashing	0	0	-	-	-	-
Backerplate (three or four-sided)	-	-	0	-	-	-
Cast Iron Surround Kit / Flashing	0	0	0	-	-	-
Extrusion/Contemporary Trim Kits	-	-	0	-	-	-
MIRRO-FLAME [™] Porcelain Reflective Radiant Panels	0	0	0	-	-	-
Sandstone Decorative Brick Panels	0	0	0	-	-	0
Blower Kit	S	S	S	S	S	0
Millivolt Wall Thermostat	0	0	0	0	0	0
On/off Remote Control	0	0	0	0	0	0
Thermostatic Remote Control	0	0	0	0	0	0
Accent Bars (Painted Metallic Black, Satin Chrome Plated or 24 Karat Gold Plated finishes)	-	-	-	0	0	-
Andirons (Available in Painted Black finish)	0	0	0	0	0	0
Riser Box - Available in Painted Black finish	0	0	0	-	-	-
Alternate River Rock Media Kit	0	-	-	-	-	-

- = Not Available 0= Optional S= Standard
• Must be purchased to complete unit

Backer Plates

Available as three or four-sided in Painted Black finish.





CDI-30

Features & Benefits

- 371 sq. in. glass area
- No electricity required to light or operate - millivolt system ensures reliable use even during power failures
- Exclusive PHAZER® logs with glowing embers standard
- MIRRO-FLAME® Porcelain Reflective Radiant Panels
- Faceplates available in brushed nickel, brushed copper and painted black
- 100% SAFE GUARD® automatic gas shut off for your peace of mind
- Hinged, heat radiating ceramic glass door
- Impressive 85% Steady State maximum efficiency
- Heat circulating blower with variable speed control and thermostatic on/off switch
- Optional remote with digital read out and thermostatic control
- Optional decorative accessories available to transform your gas fireplace insert to the exact design you need
- Optional painted black riser box available to raise the unit to accommodate larger fireplace opening dimensions
- Bedroom, bathroom, bed sitting room and mobile home approved
- President's Limited Lifetime Warranty

CBI360

Features & Benefits

- 350 sq. in. glass area
- No electricity required to light or operate - millivolt system ensures reliable use even during power failures
- Double flame stainless steel burner
- Exclusive PHAZER® log set with traditional glowing charcoal embers
- 76% Steady State maximum efficiency
- Heat circulating blower system with variable speed control and thermostatic on/off switch comes standard
- 100% SAFE GUARD® automatic gas shut off for your peace of mind
- Heat radiating ceramic glass door provides clear view of the fire
- YELLOW DANCING FLAMES® fill the firebox with realistic flames
- Optional decorative accessories available to transform your fireplace insert to the exact design you need
- Optional bevelled flashing in a painted black finish with accent trim available
- Optional painted black riser box available to raise the unit to accommodate larger fireplace opening dimensions
- Optional remote with digital read out and thermostatic control
- Bedroom and bed sitting room approved
- President's Limited Lifetime Warranty

CDIZC

Features & Benefits

- 440 sq. in. glass area
- No electricity required to light or operate - millivolt system ensures reliable use even during power failures
- Exclusive PHAZER® log set with traditional glowing charcoal embers
- 85% Steady State maximum efficiency
- Heat circulating blower system with variable speed control and thermostatic on/off switch comes standard
- 100% SAFE GUARD® automatic gas shut off for your peace of mind
- Heat radiating ceramic glass window provides clear view of the fire
- YELLOW DANCING FLAMES® fill the firebox with realistic flames
- Three or four-sided aluminum extrusion trim kit available in painted textured satin black finish
- Three or four-sided backer plates
- Optional remote with digital read out and thermostatic control
- Optional decorative accessories available to transform your unit to the exact design you need
- Bedroom, bathroom, bed sitting room and mobile home approved
- President's Limited Lifetime Warranty

	CDI-30
BTU's (Input)	24,500
Venting*	Top 3" & 3"
Glass Type	Ceramic
Glass Size	
Height	13 5/16"
Width	27 7/8"
Efficiencies	
EnerGuide	64.5%
AFUE	60.02%
Steady State	85%
Dimensions (Height x Front Width x Depth)	
Minimum Opening	21 3/4" x 28" x 18"
Mobile Home Certified	Yes

* 2" optional liner for intake air

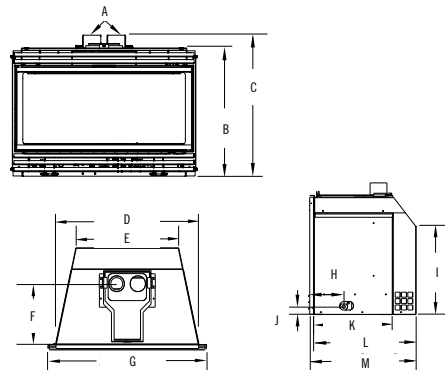

	A	B	C	D	E	F	G	H	I	J	K	L	M
CDI-30	3" DIA.	21 3/4"	23 1/4"	27 7/8"	19 5/8"	11 1/4"	30 3/8"	5 1/4"	13 3/4"	1 1/4"	13 3/4"	17 1/4"	18 3/4"

	CBI360
BTU's (Input)	24,000
Venting*	Top - Natural Vent (B) 3"
Glass Type	Ceramic
Glass Size	
Height	11 3/4"
Width	29 3/4"
Efficiencies	
EnerGuide	62.3%
AFUE	-
Steady State	76%
Dimensions (Height x Front Width x Depth)	
Minimum Opening	17 1/2" x 25 1/2" x 16 1/2"
Mobile Home Certified	No

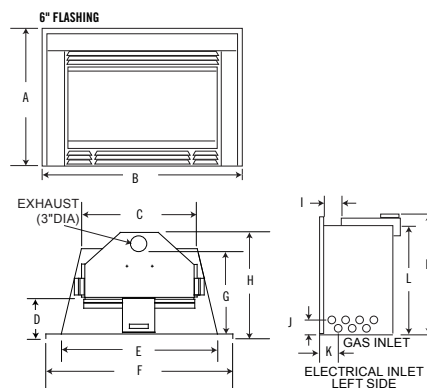

	A	B	C	D	E	F	G	H	I	J	K	L	M
CBI360	27 1/2"	43"	18 1/2"	8"	25"	30 3/4"	13 3/2"	17 1/2"	7"	2 1/2"	3"	17 3/4"	22"

	CDIZC
BTU's (Input)	24,000
Venting*	Top 3" & 3"
Glass Type	Ceramic
Glass Size	
Height	15 5/8"
Width	28 1/8"
Efficiencies	
EnerGuide	65.5%
AFUE	65%
Steady State	85%
Dimensions (Height x Front Width x Depth)	
Minimum Opening	14 1/2" x 25" x 11"
Mobile Home Certified	Yes

* 2" optional liner for intake air

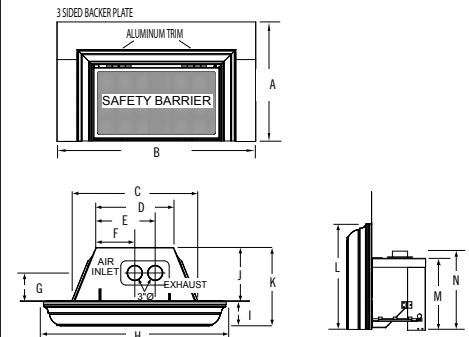

	A	B	C	D	E	F	G	H	I	J	K	L	M	N
CDIZC	27"	44 3/4"	25"	15 5/8"	11 1/4"	7 1/4"	5 3/4"	36"	4 1/2"	10 1/4"	15 1/2"	20 3/4"	14"	15 1/4"



CDVS280

Features & Benefits

- 260 sq. in. glass area
- No electricity required to light or operate - millivolt system ensures reliable use even during power failures
- Includes heat activated variable speed blower
- Easy clean hinged door
- Exclusive PHAZER® log set with traditional glowing charcoal embers
- Metallic black accent bar, ornamental inset and trivet come standard
- 85% Steady State maximum efficiency
- Stainless steel flex connector and shut off
- 100% SAFE GUARD® automatic gas shut off for your peace of mind
- YELLOW DANCING FLAMES® fill the firebox with realistic flames
- Door available in metallic black, satin chrome plated or 24 Karat gold plated finishes
- Optional decorative accessories available to transform the design of your stove
- Optional B-vent adapter kit available
- Optional remote with digital read out and thermostatic control
- Bedroom, bathroom, bed sitting and mobile home approved
- President's Limited Lifetime Warranty

CDVS500

Features & Benefits

- 357 sq. in. glass area
- No electricity required to light or operate - millivolt system ensures reliable use even during power failures
- Triple burner "turbo boosts" the heating power to increase the already impressive 30,000 BTU's to 44,000 BTU's
- Includes heat activated variable speed blower
- Easy clean hinged door
- Exclusive PHAZER® log set with traditional glowing charcoal embers
- Metallic black accent bar, ornamental inset and trivet come standard
- 84% Steady State maximum efficiency
- Stainless steel flex connector and shut off
- 100% SAFE GUARD® automatic gas shut off for your peace of mind
- Door available in metallic black, satin chrome plated or 24 Karat gold plated finishes
- Optional B-vent adapter kit available
- Optional decorative accessories available to transform the design of your stove
- Optional remote with digital read out and thermostatic control
- Bedroom, bathroom, bed sitting and mobile home approved
- President's Limited Lifetime Warranty

CDVS600

Features & Benefits

- 394 sq. in. glass area
- Electronic ignition with battery back-up
- Larger viewing area with its new updated design
- Elegant arched front and a sleek, sophisticated outer casting design
- ACS (Anti-Condensation Switch) controls pilot usage for cold climate installations
- Exclusive PHAZER® log set with traditional glowing charcoal embers
- Fuel saving electronic ignition with battery back-up and on/off switch
- Built-in adjustable flame/heat control for maximum comfort and efficiency
- Decorative cast iron trivets for rear vent installations (available in painted black finish)
- Optional remote with digital read out and thermostatic control
- Optional decorative accessories available to transform your stove to the exact design you need
- Optional B-vent adaptor kit
- Optional heat circulating blower kit with variable speed and thermostatic control
- Bedroom, bathroom, bed sitting room and mobile home approved
- President's Limited Lifetime Warranty

	CDVS280
BTU's (Input)	30,000
Venting	Top* 4" & 7"
Minimum Clearances to Combustibles	
Corner	1"
Rear	2"
Sides	7"
Glass Type	Ceramic
Glass Size	
Height	11 3/8"
Width	24 1/2"
Efficiencies	
EnerGuide	57.4%
AFUE	65%
Steady State	85%
Mobile Home Certified	Yes

	CDVS500
BTU's (Input)	44,000
Venting	Top* 4" & 7"
Minimum Clearances to Combustibles	
Corner	1"
Rear	2"
Sides	7"
Glass Type	Ceramic
Glass Size	
Height	13 7/8"
Width	25 3/4"
Efficiencies	
EnerGuide	70%
AFUE	67%
Steady State	84%
Mobile Home Certified	Yes

	CDVS600
BTU's (Input)	35,000
Venting	Top*/Rear 4" & 7"
Minimum Clearances to Combustibles	
Corner	2"
Rear	6"
Sides	6"
Glass Type	Ceramic
Glass Size	
Height	18 3/4"
Width	21"
Efficiencies	
EnerGuide	63.1%
AFUE	64%
Steady State	78%
Mobile Home Certified	Yes

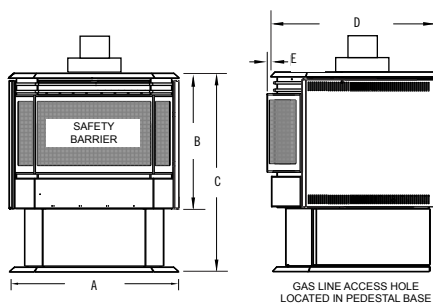

	A	B	C	D	E
CDVS280	22 1/2"	17 3/4"	26 3/4"	18 1/2"	1 3/4"

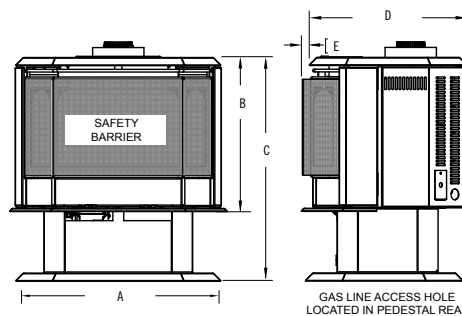

	A	B	C	D	E
CDVS500	28 3/4"	21"	30 3/4"	21 1/4"	2"

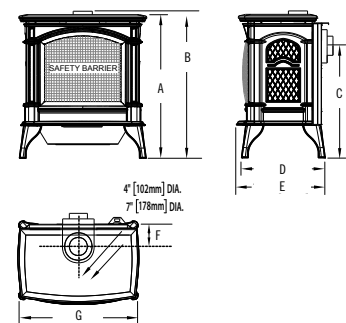

	A	B	C	D	E	F	G
CDVS600	30 3/4"	37"	24"	17 3/4"	19 1/2"	5 1/2"	27"

* B-vent adaptable. Figures may vary with individual conditions such as floor plan layout, insulation value/heat loss of the house and geographical location. Consult your owner's manual for complete and up-to-date installation instructions and proper clearances to combustible materials.



QUALITY PROMISE

All Continental® products are built to the strictest quality standards and only the highest grade materials are used. The computerized production processes, pride in workmanship and serious commitment to our achieved ISO9001-2008 certification, ensure many years of dependable performance.

VERSATILE INSTALLATION

Install in your home above or below grade, in any room even in bedrooms, bathrooms and kitchens. Inserts can be installed into existing masonry or prefabricated fireplaces. Direct vent models can be vented up to 20 feet horizontally through a wall, 40 feet vertically through the roof or below grade with a periscope. For all models we offer the smallest, architecturally pleasing vent terminal in the industry.

MAXIMUM EFFICIENCY

Our sealed combustion technology in our Direct Vent models uses outside air for combustion eliminating heat loss and cold drafts associated with conventional fireplaces. All Continental® models are designed to maximize efficiency levels with special heat retaining components.

CONVENIENCE

If all the conveniences of gas inserts and stoves aren't enough, enjoy full relaxation with Continental's remote controls. Available with an easy-to-read backlit digital readout of the room temperature and includes a child proof safety lock ensuring your peace of mind.

A RELIABLE ECONOMICAL HEATING SOURCE

Continental® products can save home heating costs by as much as 30% (Zone Heating by heating the rooms you use most) and provide reliable heat during power failures. No power? No problem! Continental's built-in millivolt system or electronic ignition requires no electricity to light or operate.

SAFETY FEATURES

100% SAFE GUARD® gas control system automatically and quickly shuts off the gas supply for your peace of mind.

HEAT TRANSFERRING CERAMIC GLASS

Ceramic glass provides an excellent temperature transfer allowing maximum heat to radiate into the room. Some models use heat resistant tempered glass.

REALISTIC CERAMIC FIBRE LOGS

Continental's configuration of realistic logs create a cozy and natural wood burning atmosphere.

RELIABLE BURNER SYSTEM & ADJUSTABLE FLAME

Our advanced YELLOW DANCING FLAMES® provides maximum heat and flame pattern. For less heat, simply reduce the input with the built-in 50% flame/heat adjustment for maximum comfort and efficiency.

ENVIRONMENTALLY FRIENDLY

Clean burning, convenient natural gas or propane provides an environmentally safe energy source - indoors and outdoors. Continental® products are designed to provide an environmentally friendly energy source.

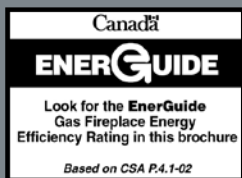

ENERGUIDE - A Canadian efficiency standard based on frequent, short start-up and cool-down cycles. All appliances sold in Canada are subject to this EnerGuide rating system. AFUE - A US efficiency standard (Department of Energy) based on extended on/off cycles, more typical of fireplace usage. STEADY STATE - Reflects the highest possible overall heating efficiency. Years of research, design and testing have enhanced optimum performance allowing Continental® products to achieve some of the highest heater rating efficiencies on the market. Our products continuously surpass industry standards not only in appearance but in efficiency and performance.

Consult your owner's manual for complete installation instructions, accurate framing dimensions and proper clearances to combustible materials. Installations shown may not be accurate to code. Check all local and national building codes and gas regulations. Products may not be exactly as shown. Flame height and activity is influenced by varying vent configurations and may not appear as shown. All specifications are subject to change without prior notice due to on-going product improvements. BTU's listed in brochure reflect natural gas applications. Continental® is a registered trademark of Wolf Steel Ltd. ©Wolf Steel Ltd.



- 103 Miller Drive, Crittenden, Kentucky, USA 41030
- 24 Napoleon Road, Barrie, Ontario, Canada L4M 0G8
- 7200 Trans Canada Highway, Montreal, Quebec, Canada H4T 1A3

Tel: (705) 721-1212 Fax: (705) 722-6031
continentalfireplaces.com



Authorized Dealer

